

ULTRATECH

FCP200x50-Ø20

EAN 4031582445169

Wheel centre made of cast iron, Tread: Polyurethane, casted, Ultratech, suitable especially for higher speeds of up to 16 km/h, precision ball bearing

TENTE

BETTER MOBILITY. BETTER LIFE.



Obrázky se mohou lišit od skutečného produktu

Technické údaje

Průměr kolečka	200 mm
Šířka běhounu	50 mm
Osa kolečka Ø	20 mm
Délka náboje	60 mm
Teplota	- 20 / + 60 °C
Standard	EN 12532
Hmotnost	1.3 kg
Tvrdość běhounu	Shore A 92
Dynamická nosnost	800 kg
Statická nosnost	1600 kg

Vlastnosti

Valivý odpor	● ● ● ● ○
Hlučnost pohybu	● ● ● ○ ○
Opotřebení	● ● ● ● ○
Ochrana proti korozi	● ● ● ○ ○

Dimensions

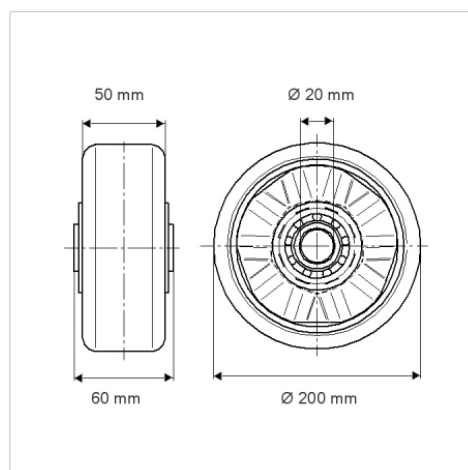

Structure & Mounting

